

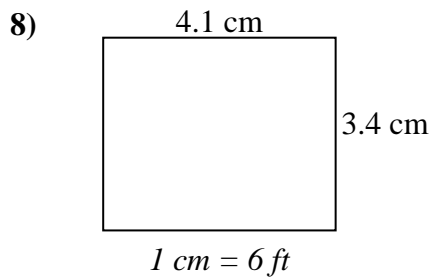

Determine the actual width, height and area of each scale rectangle.

Round the area to the nearest whole number.

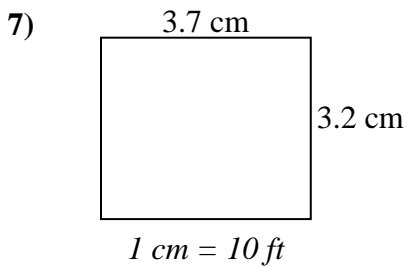
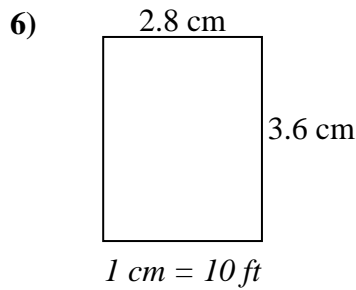
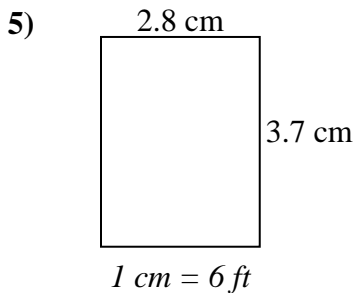
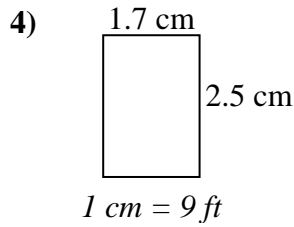
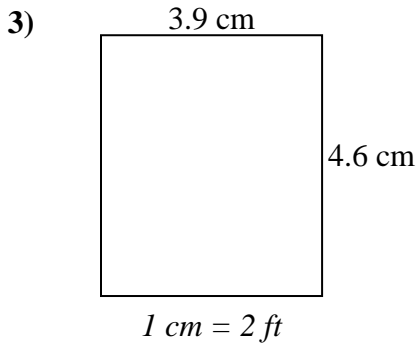
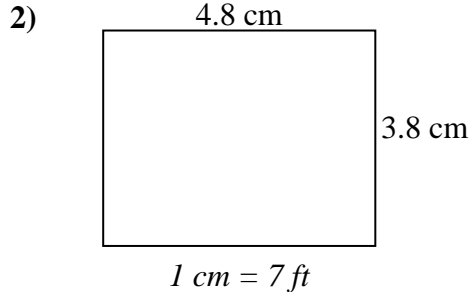
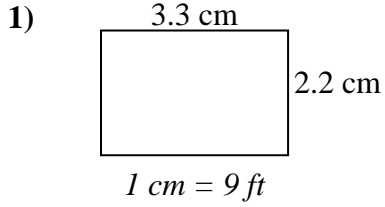

Answers

1. \_\_\_\_\_
2. \_\_\_\_\_
3. \_\_\_\_\_
4. \_\_\_\_\_
5. \_\_\_\_\_
6. \_\_\_\_\_
7. \_\_\_\_\_
8. \_\_\_\_\_



Determine the actual width, height and area of each scale rectangle.

Round the area to the nearest whole number.

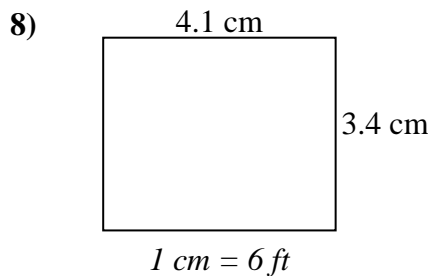
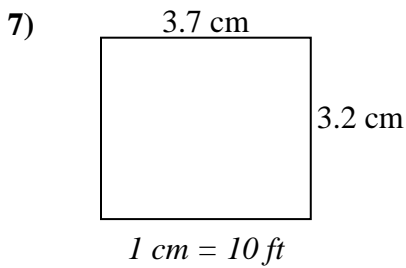
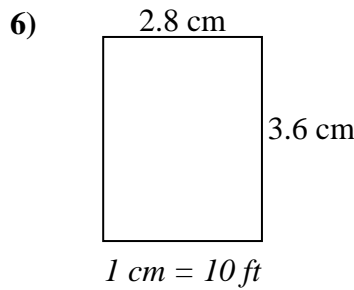
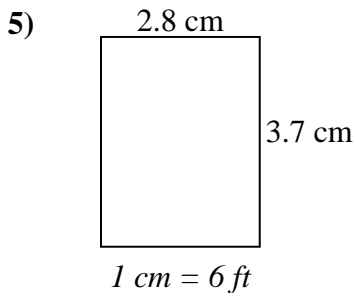
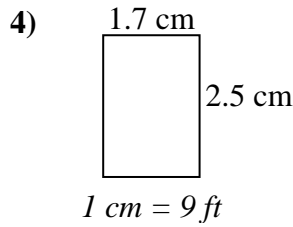
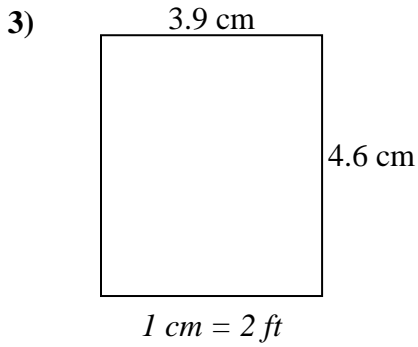
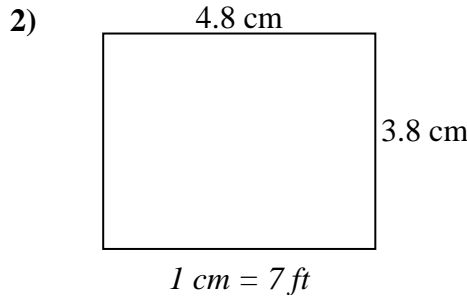
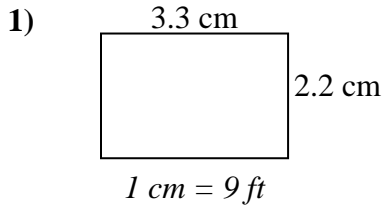

Answers

1. 29.7   19.8   588
2. 33.6   26.6   894
3. 7.8   9.2   72
4. 15.3   22.5   344
5. 16.8   22.2   373
6. 28   36   1,008
7. 37   32   1,184
8. 24.6   20.4   502