

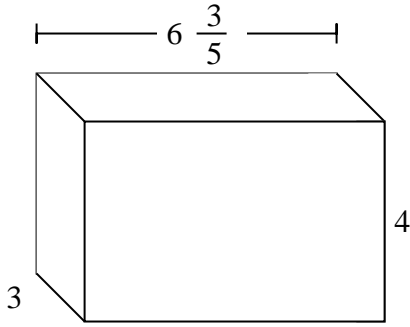

Fill each rectangular prism with cubes to determine the volume. Each prism's unit is measured in cm (not to scale).

Ex)

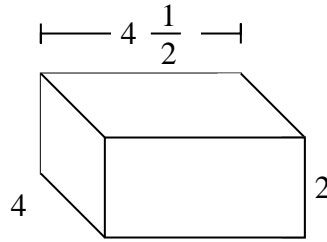

1)

Ex. $79\frac{1}{5}$ cm

1. _____

2. _____

3. _____

4. _____

5. _____

6. _____

7. _____

2)

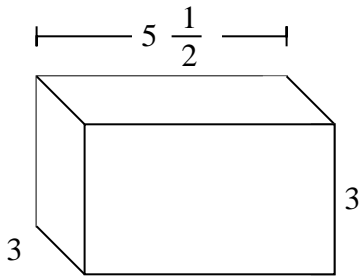

3)

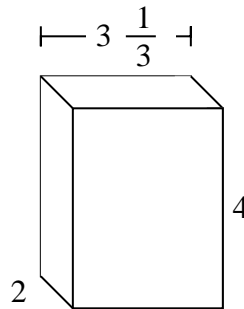

4)

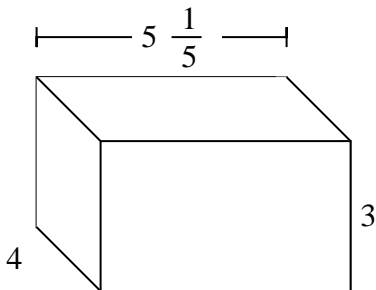

5)

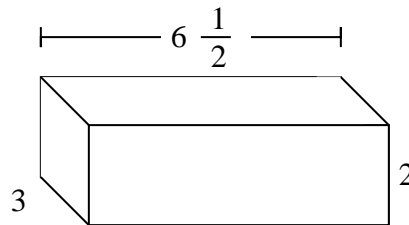

6)

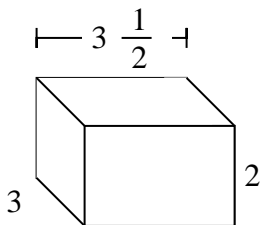

7)

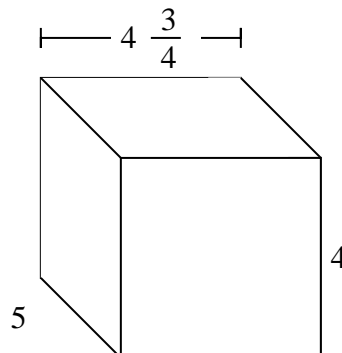

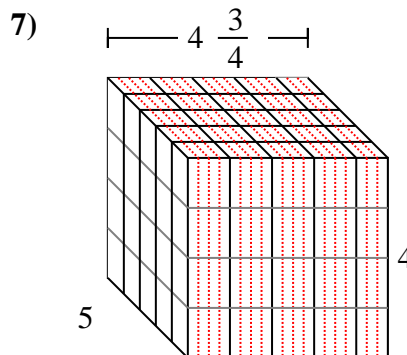
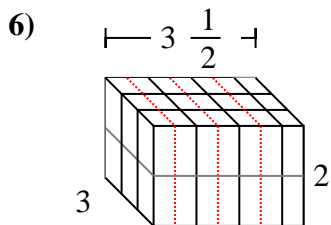
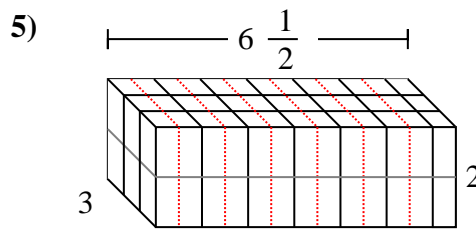
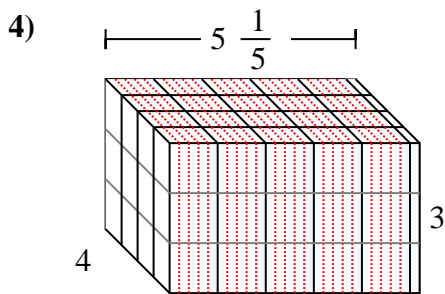
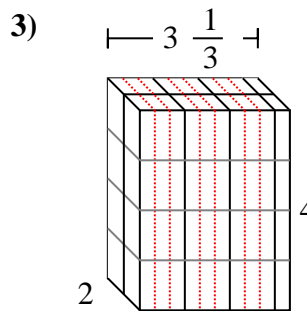
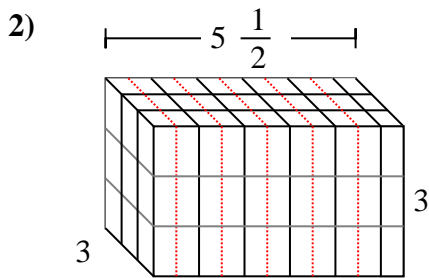
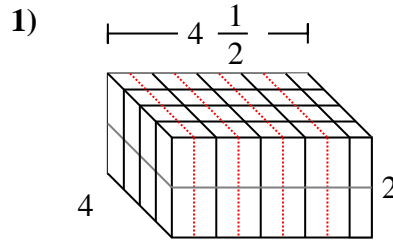
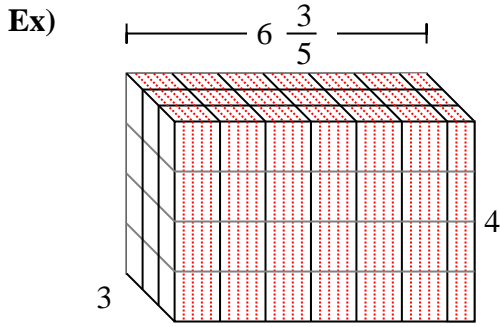

Fill each rectangular prism with cubes to determine the volume. Each prism's unit is measured in cm (not to scale).

**Answers**Ex. 79 $\frac{1}{5}$ cm1. 36 cm2. 49 $\frac{1}{2}$ cm3. 26 $\frac{2}{3}$ cm4. 62 $\frac{2}{5}$ cm5. 39 cm6. 21 cm7. 95 cm