

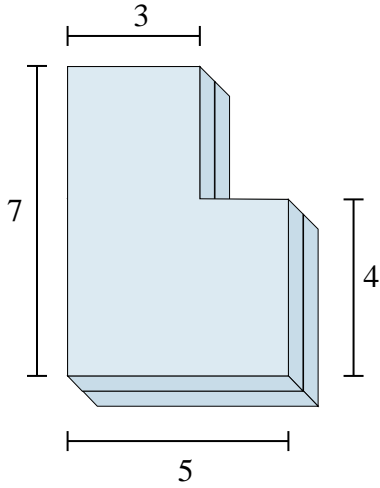

Find the total volume of each figure shown. Measured in cm (not to scale).

Answers

1)



2)

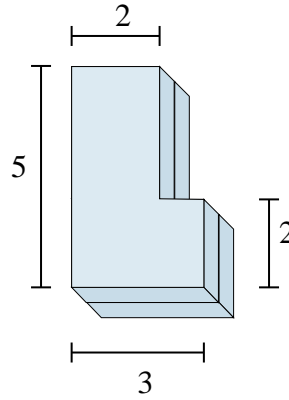

1. \_\_\_\_\_

2. \_\_\_\_\_

3. \_\_\_\_\_

4. \_\_\_\_\_

5. \_\_\_\_\_

6. \_\_\_\_\_

3)

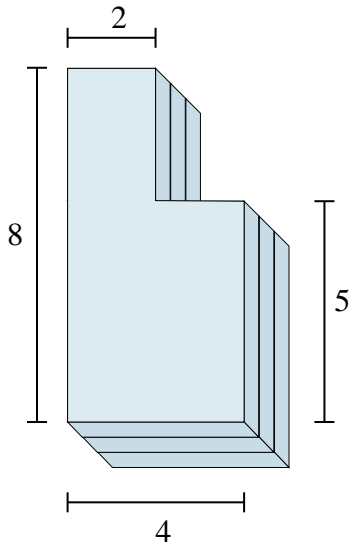

4)

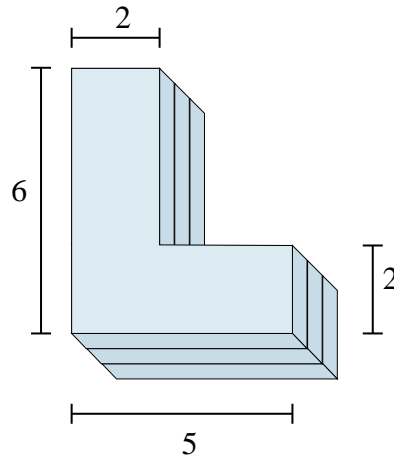

5)

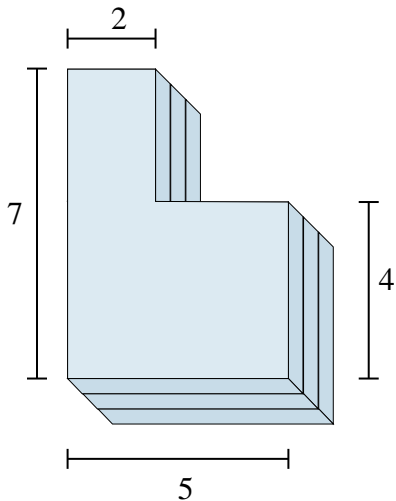

6)

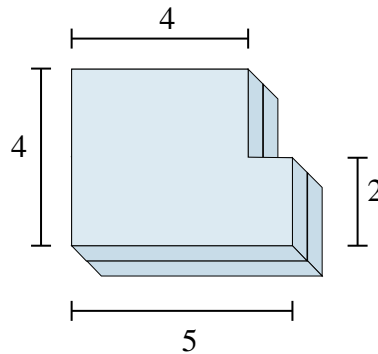



Find the total volume of each figure shown. Measured in cm (not to scale).

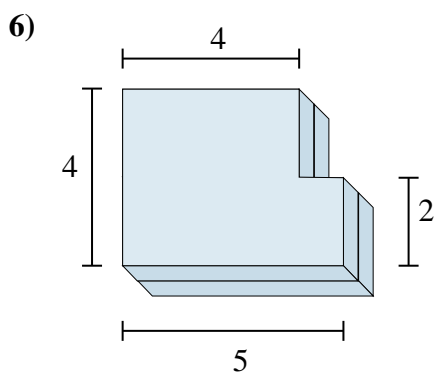
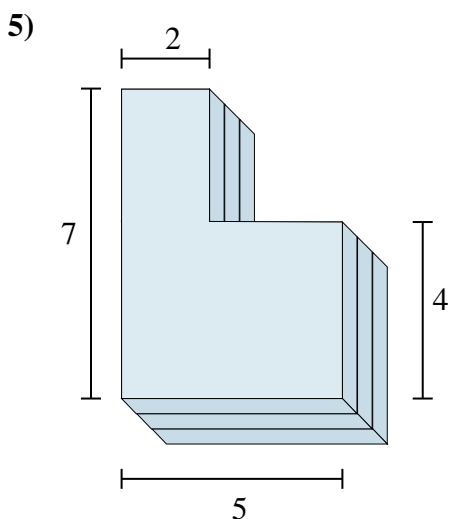
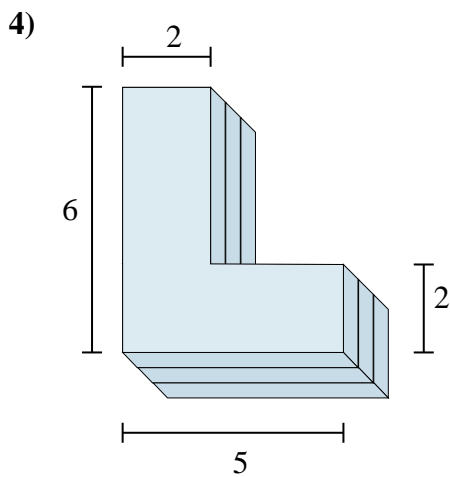
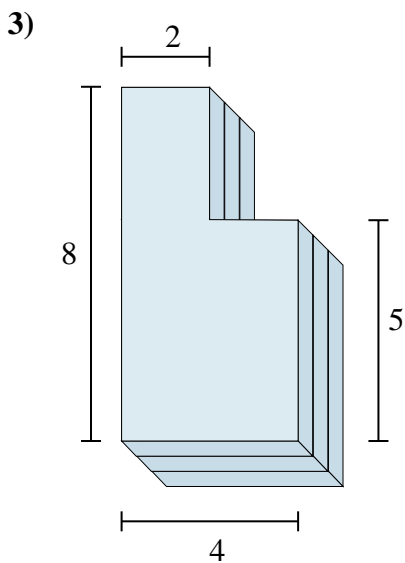
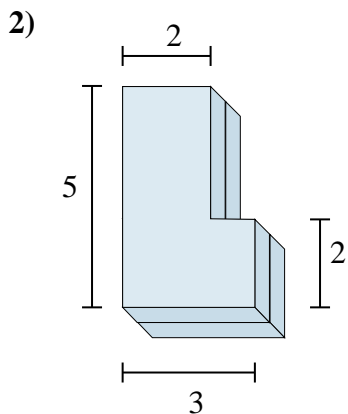
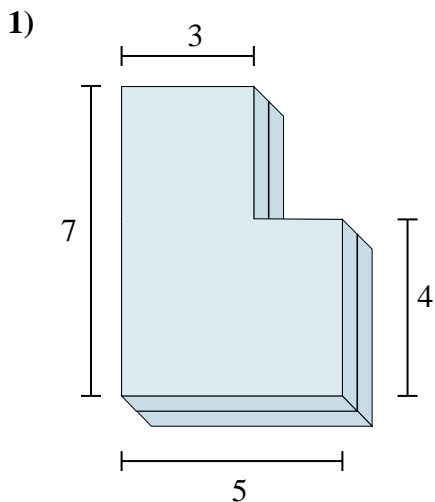

Answers

1. **58 cm<sup>3</sup>**

2. **24 cm<sup>3</sup>**

3. **78 cm<sup>3</sup>**

4. **54 cm<sup>3</sup>**

5. **78 cm<sup>3</sup>**

6. **36 cm<sup>3</sup>**



Find the total volume of each figure shown. Measured in cm (not to scale).

Answers

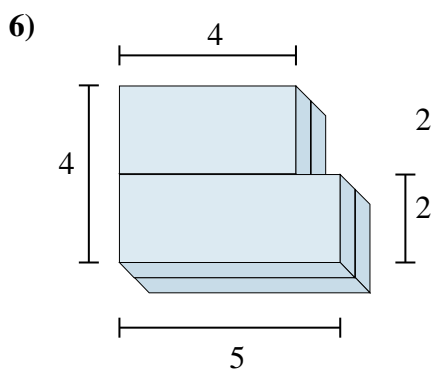
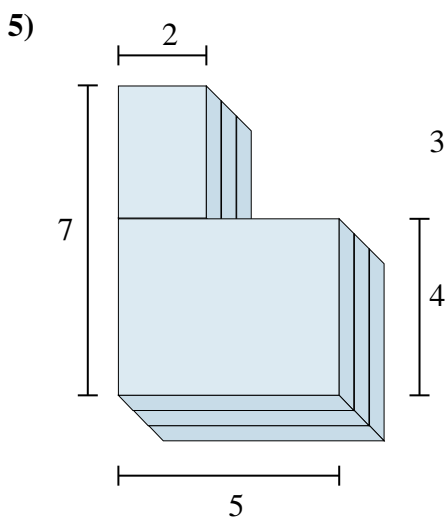
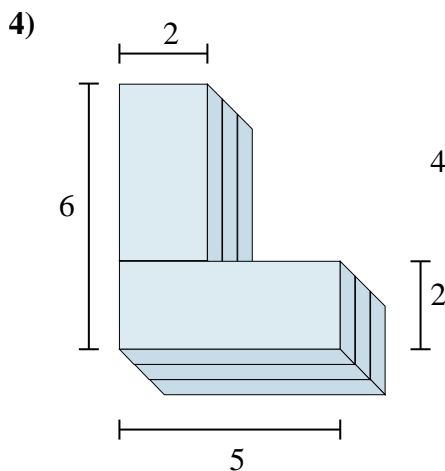
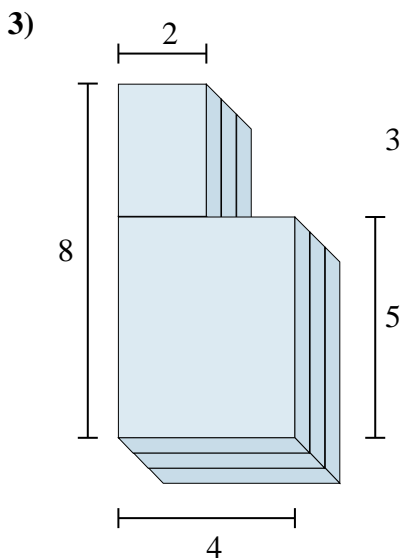
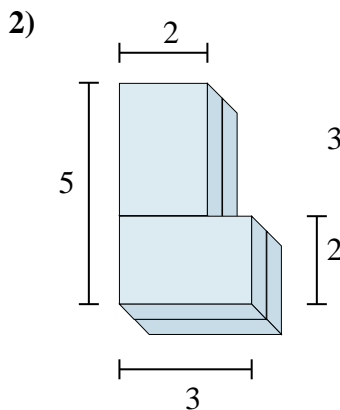
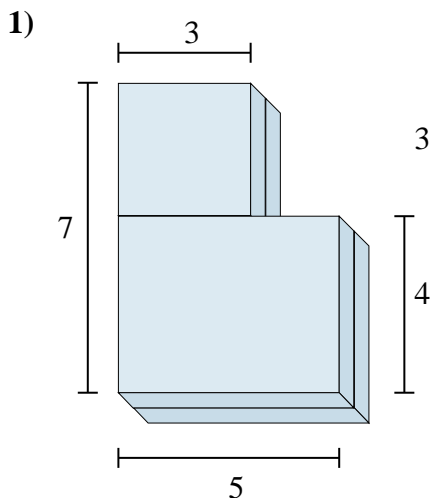

1. \_\_\_\_\_
2. \_\_\_\_\_
3. \_\_\_\_\_
4. \_\_\_\_\_
5. \_\_\_\_\_
6. \_\_\_\_\_