

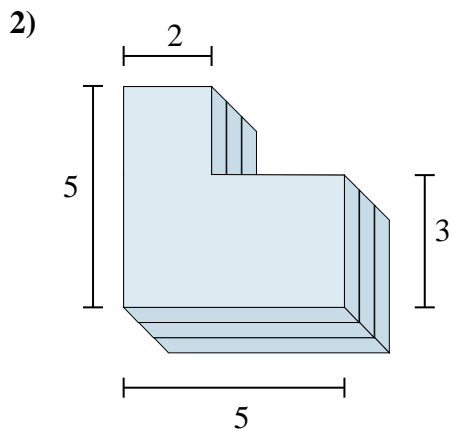

Find the total volume of each figure shown. Measured in cm (not to scale).

Answers

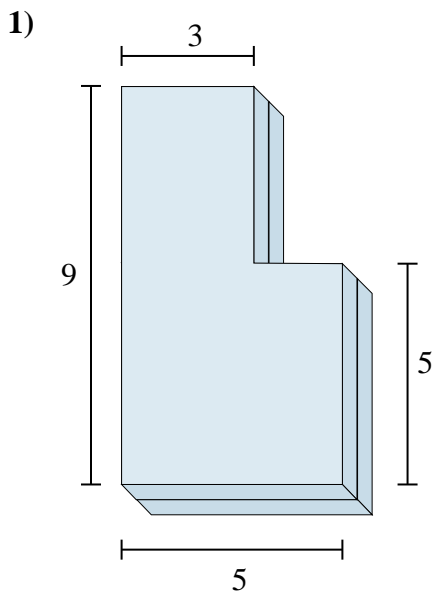

1. _____
2. _____
3. _____
4. _____
5. _____
6. _____

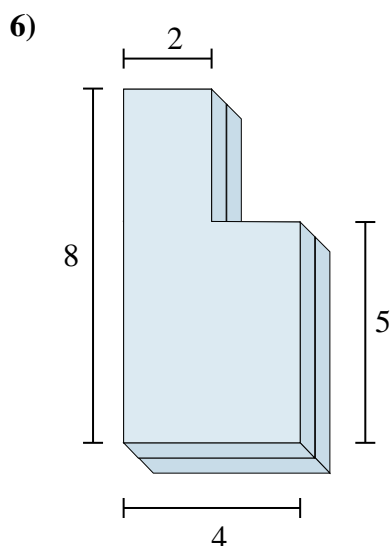
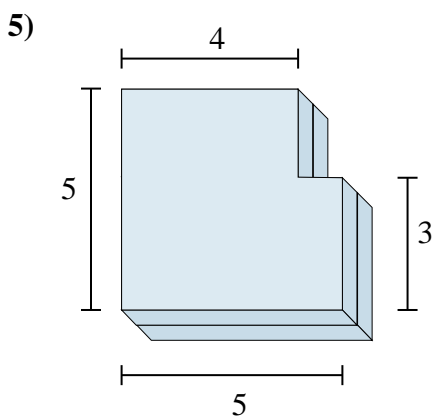
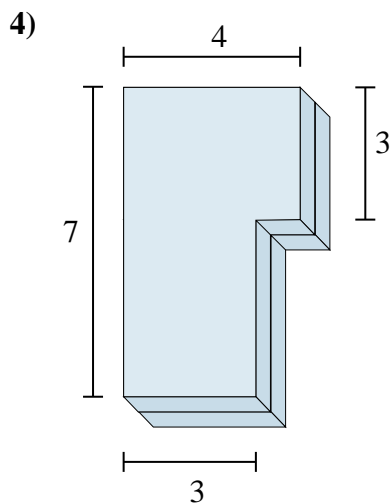
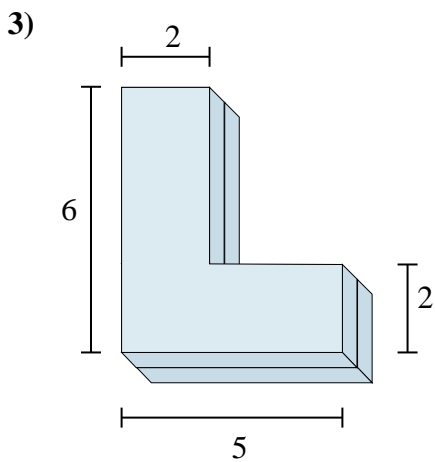



Find the total volume of each figure shown. Measured in cm (not to scale).

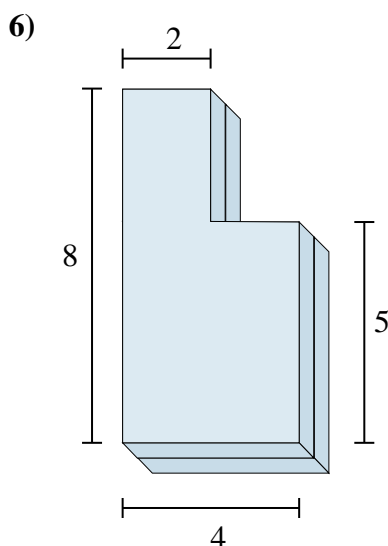
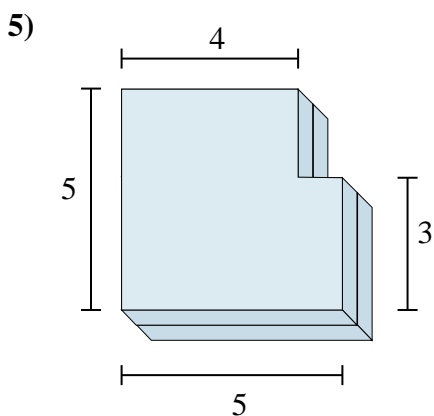
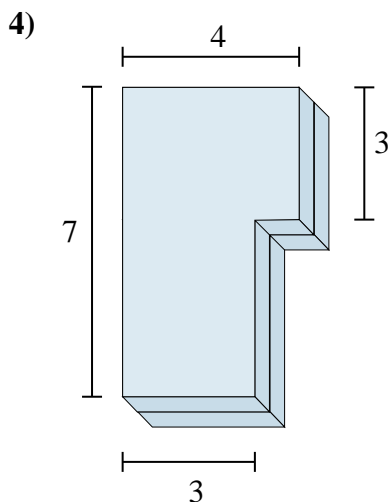
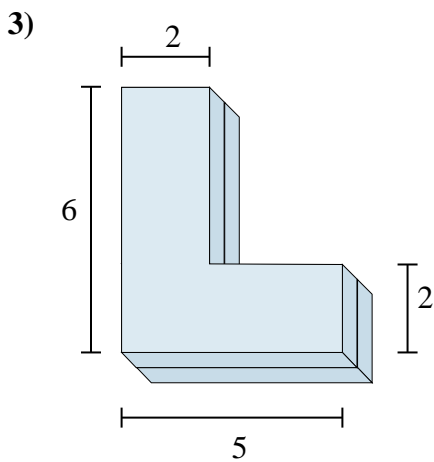
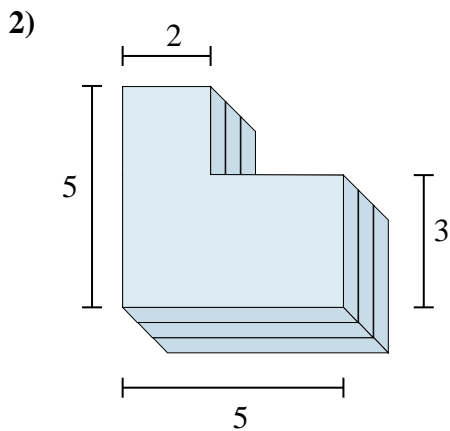
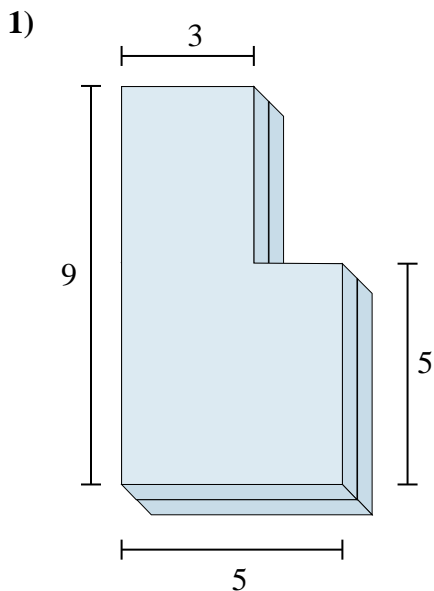

Answers

1. 74 cm³

2. 57 cm³

3. 36 cm³

4. 48 cm³

5. 46 cm³

6. 52 cm³



Find the total volume of each figure shown. Measured in cm (not to scale).

Answers

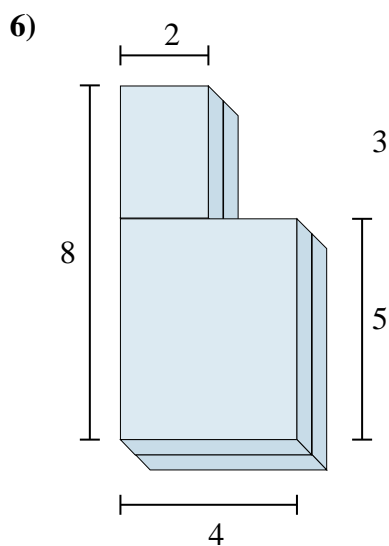
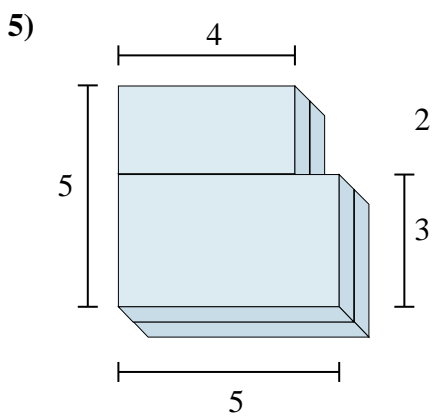
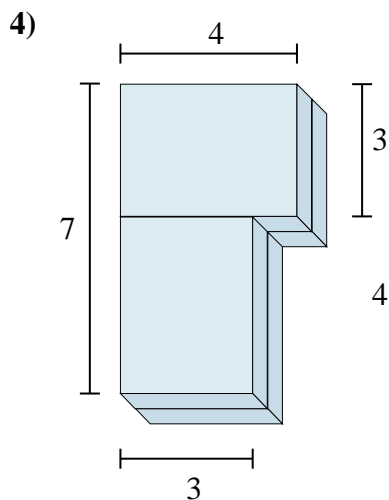
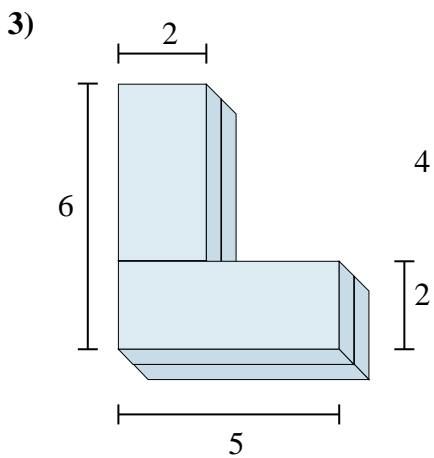
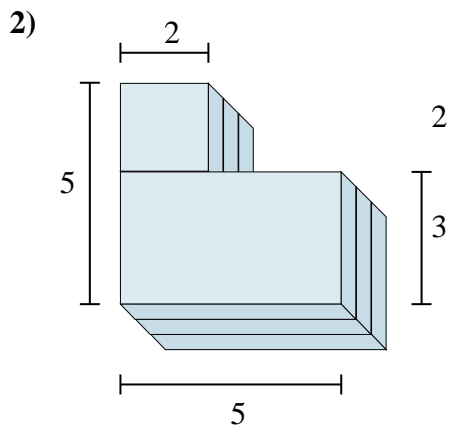
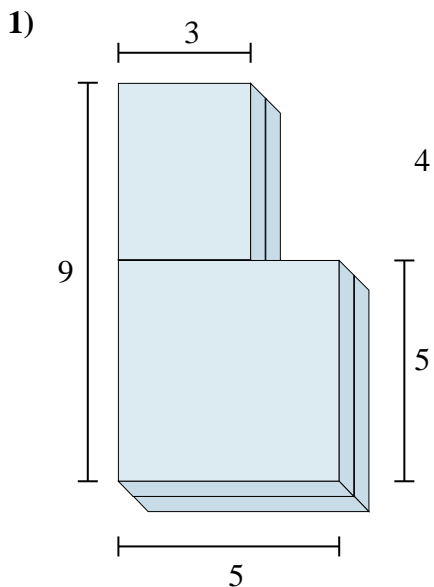

1. _____
2. _____
3. _____
4. _____
5. _____
6. _____